

GW-LWD Geosteering Technology

China National Petroleum Corporation

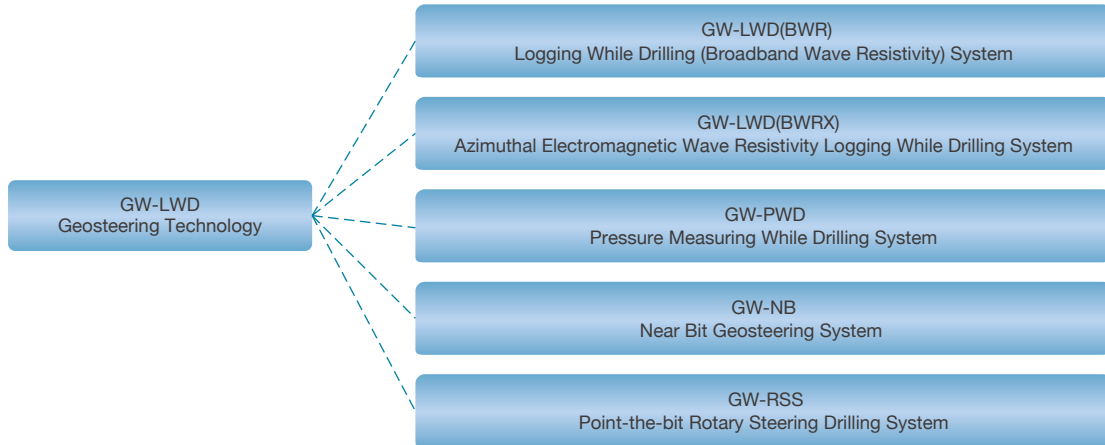

LWD geosteering is a key solution to improve reservoir encountering rate for directional wells and horizontal wells. CNPC Great Wall Drilling Engineering Company (GWDC) has developed a series of tools, such as GW-logging while drilling system (BWR), GW-azimuthal electromagnetic wave resistivity logging while drilling system (BWRX), GW-near bit geosteering system (NB), and GW-point-the-bit rotary steering drilling system (RSS), which are suitable for tapping thin oil pays, marginal reservoirs and difficult-to-produce reserves.



GW-Logging While Drilling System (BWR)

GW-logging while drilling system (BWR), namely Great Wall logging while drilling (broadband wave resistivity) system, is mainly composed of surface software and hardware platform, measurement while drilling (MWD) system with positive pulse signal, electromagnetic wave resistivity logging tool and natural gamma logging tool. It can work under the circumstance with the highest formation temperature and pressure of 150 °C and 140MPa. The system provides three borehole trajectory parameters, one natural gamma logging curve, and eight electromagnetic wave resistivity curves of different measuring range.

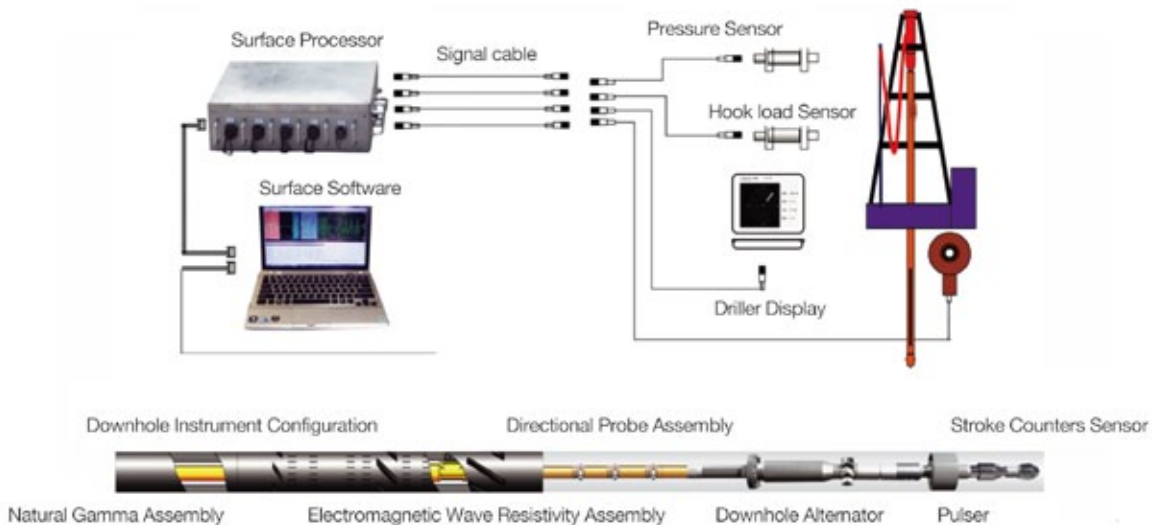

GW-Azimuthal Electromagnetic Wave Resistivity Logging While Drilling System (BWRX)

GW-azimuthal electromagnetic wave resistivity logging while drilling system (BWRX) is a leading-edge device which can realize omni-directional (360°) resistivity imaging to the rocks around the borehole, and detect the azimuth and distance of the reservoir in a real-time manner, so as to provide reliable data for locating reservoirs through geosteering. The system is unique for three innovations: (1) the crosslink antenna concept is proposed in azimuthal resistivity measurement for the first time; (2) the symmetric + asymmetric antenna structure with four transmitters and three receivers is adopted; and (3) the fast algorithm for formation boundary detection based on the complex image theory is invented.

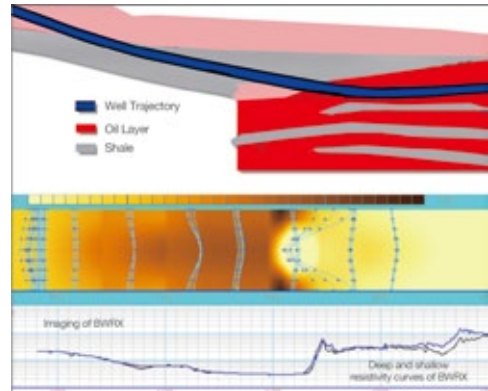

Formation Boundary Mapping in Horizontal Well

GW-Near Bit Geosteering System (NB)

GW-near bit geosteering system consists of measuring sub, receiving nipple and LWD system. The measuring sub, located between the bit and the screw rod, can obtain the well-inclination data, formation resistivity data and azimuthal gamma ray data from the section with distance not greater than 1m to the bottom hole, which allows the on-site directional drilling engineer to make adjustments directly based on the bottom hole data measured rather than the predicted bottom hole conditions. Meanwhile, this tool is provided with formation gamma ray imaging function, which helps to greatly improve the geosteering capabilities and reservoir encountering rate of horizontal wells.

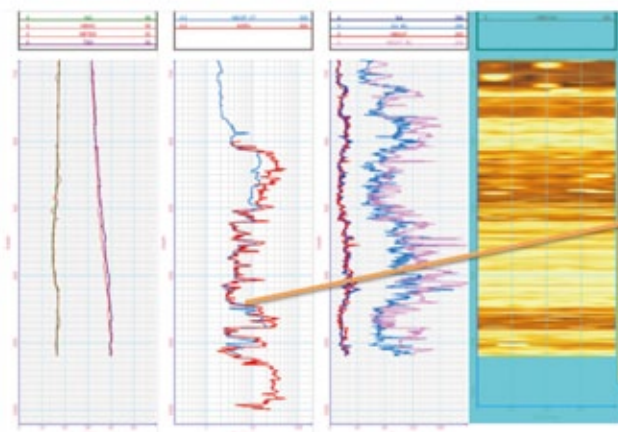
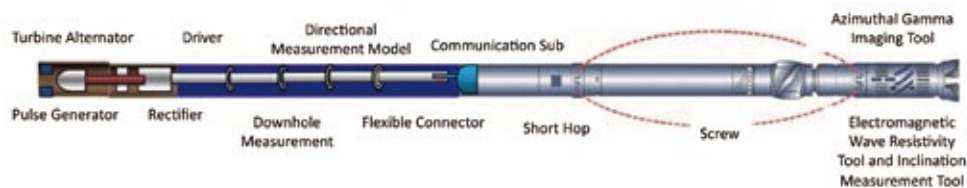

The blue curve stands for the GW-NB measurement.
The red curve stands for wireline-logging measurement.

A Data Contrast Between GW-NB and Wireline-Logging



GW-Point-the-Bit Rotary Steering Drilling System

GW-point-the-bit rotary steering system adopts the directional pilot bit, which can realize efficient trajectory control and smooth drilling trajectory. It is powered by generator, like other GW series, with high reliability. In contrast with traditional slide steering drilling, rotary steering drilling is better performed in hole cleaning and displacement extension, as downhole tools are always running in rotation status. It is more suitable for drilling special wells in complex reservoirs in offshore oil and gas development and late development stages, such as ultradeep wells, highly challenging directional wells, cluster wells, horizontal wells, extended reach wells, multilateral wells and 3D complex-structure wells.

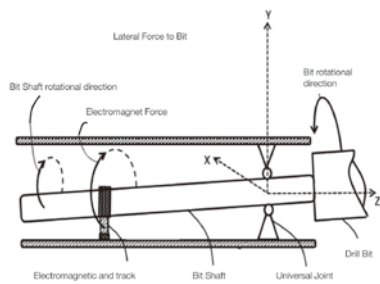

Steering Electromagnet Unit

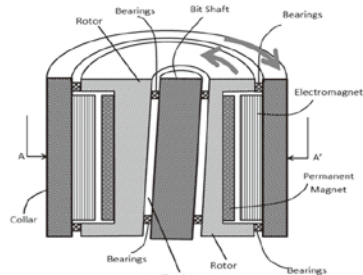

Steerable Solenoid Device

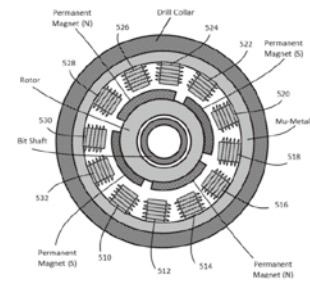

The GW-LWD (BWR) system has three models, i.e. BWR-120, BWR-172 and BWR-203, adapting to borehole sized from 149mm to 660.4mm. It is innovative in adaptive transmitting power adjustment technology, pulse signal decoding perturbation technology and man-machine interactive intelligent decoding technology. The system can realize real-time delineation drilling with its MWD function to measure the shallow and deep resistivity of electromagnetic waves in formation.

